

design  
make  
play

# SutcliffePlay

Waggon Lane  
Upton Pontefract  
West Yorkshire WF9 1JS  
Telephone +44 (0) 1977 653200  
Facsimile +44 (0) 1977 653222  
info@sutcliffeplay.co.uk  
www.sutcliffeplay.co.uk



## Altitude - Tor

### Installation Instructions

# Mnw003

# WARNING

Installation Instructions  
Impact drivers

design  
make  
play  
**SutcliffePlay**

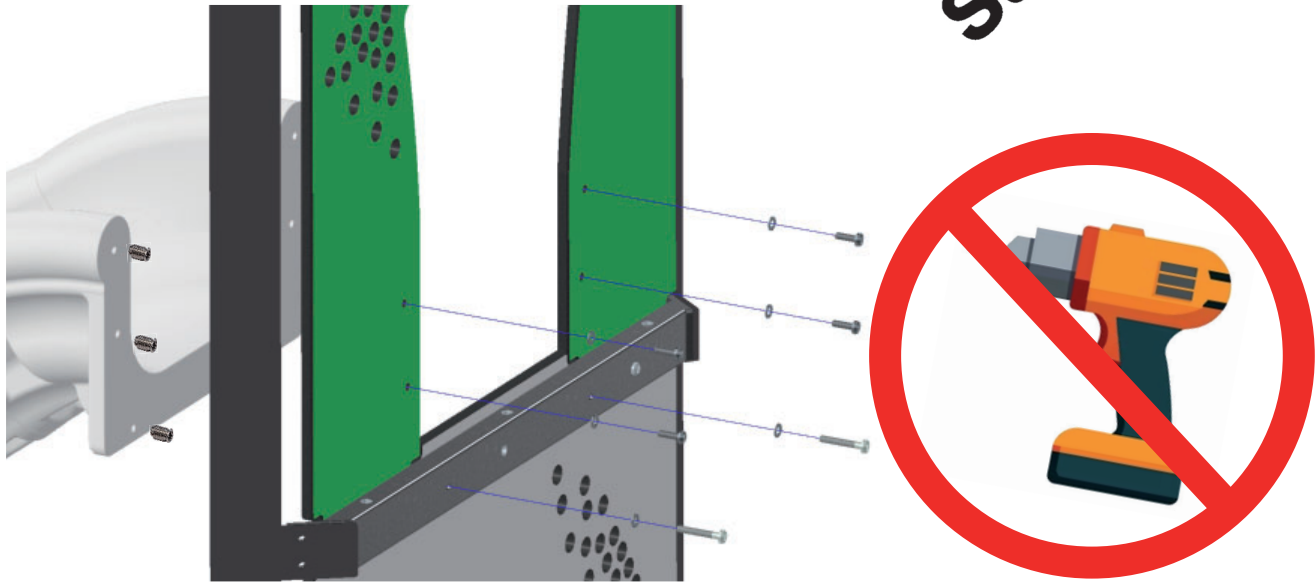

DO NOT use an impact driver when fixing bolts to self tapping inserts/threaded inserts.

The vibration of the impact driver can cause the insert to lose its grip on the post/slide and become ineffective.

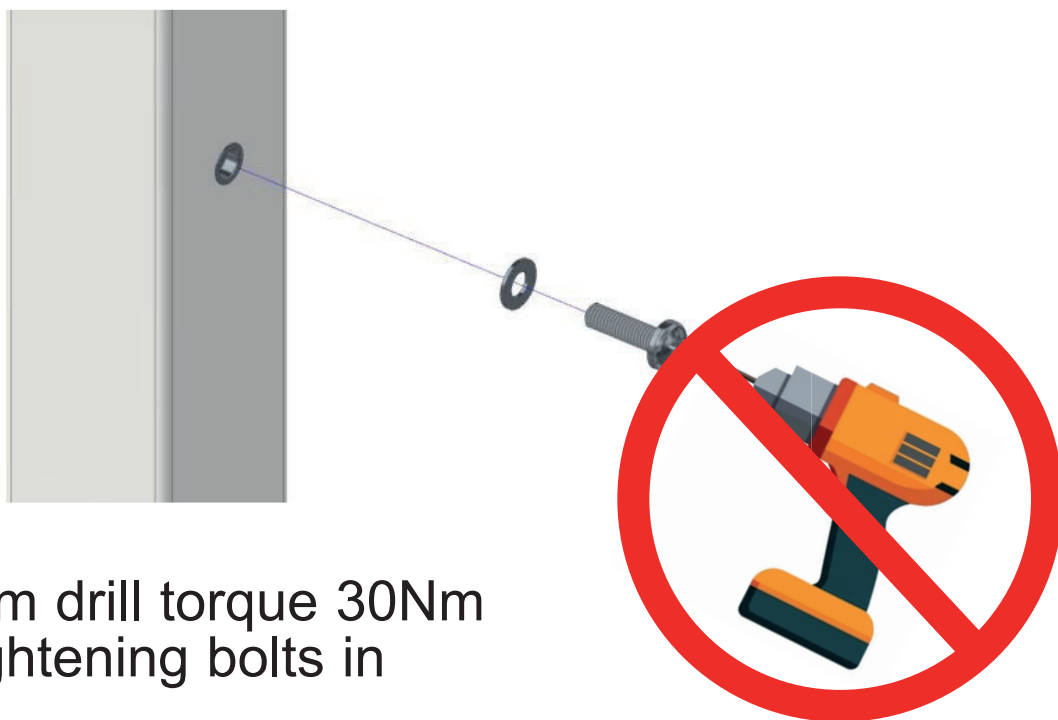

Maximum drill torque 30Nm  
when tightening bolts in  
fixings.

# Mnw003

## Unit Installation Instructions

1. Check using the Parts List that none of the components are missing.
2. Plan the final position of the play equipment ensuring there is sufficient space.
3. Sort and identify parts before assembly.
4. Excavate the foundation holes in accordance with the plan. Ensuring post holes are levelled and chocked in at the bottom of the holes.
5. Position 2 x 300mm long spragging irons into the holes provided in each post upright and stand in the foundation holes.  
Do not tighten the fixing bolts until all the activities have been assembled.
6. Assemble the activities onto the posts as per the diagrams in this document. Leave fixing bolts loose until all the activities have been assembled. Ground fixed activities need 200mm spragging irons positioned through their holes.
7. Assemble the slide as per the diagrams in this document.
8. When all activities have been assembled, tighten all the fixings, attach nut covers where necessary, ensure the unit is level and the posts are vertical.
9. Fill the foundation holes to the required depth with concrete.
10. Do not allow the equipment to be used until the concrete has set (2 - 3 days) and the required safety surfacing has been installed.
11. Tighten all fixing bolts.
12. Follow the maintenance instructions supplied.

### NB:

1. Slide runouts should be inclined downwards by approximately 2 degrees for drainage purposes.
2. During installation care must be taken to prevent hazards to children.
3. Extra care should be taken if conditions are abnormal.

# Mnw003

Unit  
Parts List



Mnw003F x1



Mnp003 x1  
Set of 8 Posts

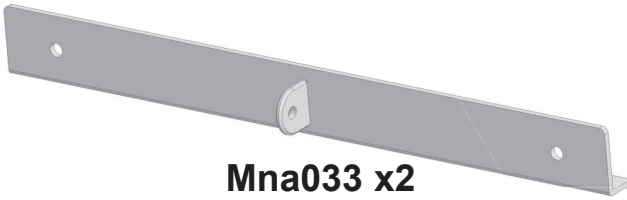

Mna033 x2

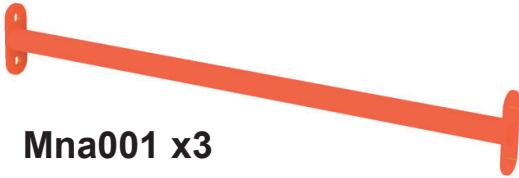

Mna001 x3

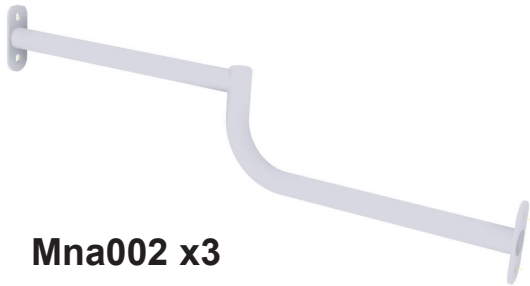

Mna002 x3



Mna004 x1



Mnd004 x2



Ths070 x1

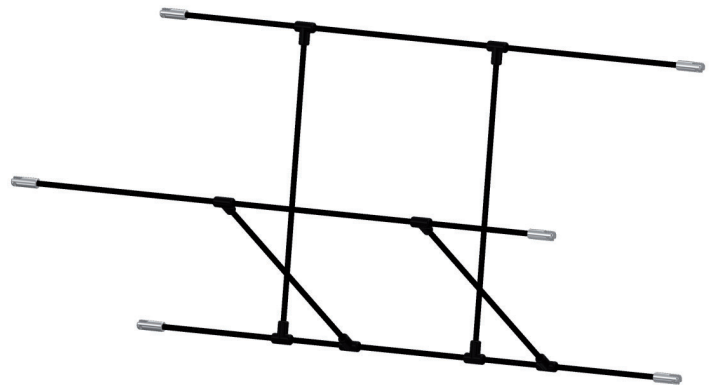

Net042 x1

# Mnw003

## Unit Parts List

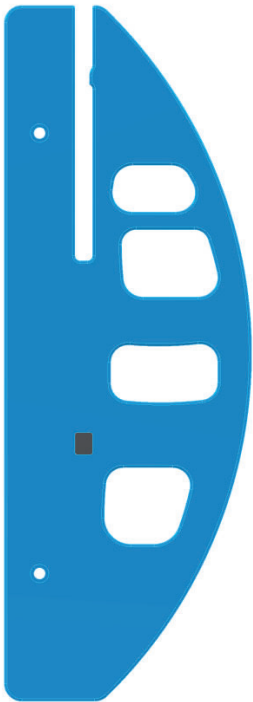

**Fta029 x2**

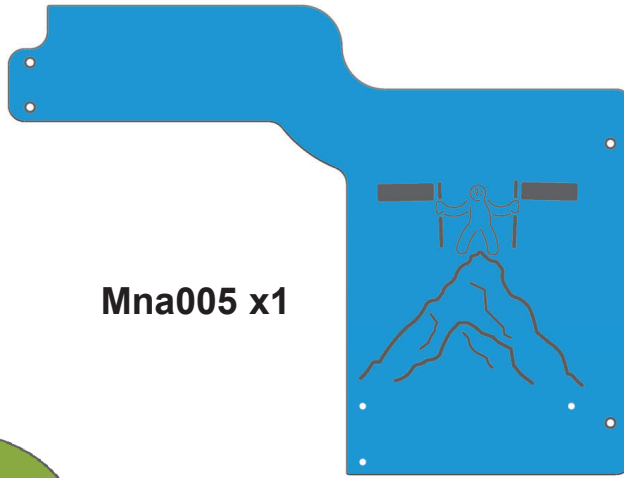

**Mna005 x1**

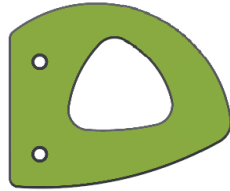

**Mna007 x2**



**Mna006 x1**

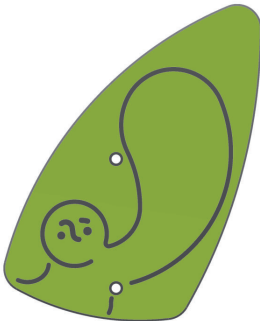

**Mna014 x1**



**Mna008 x1**

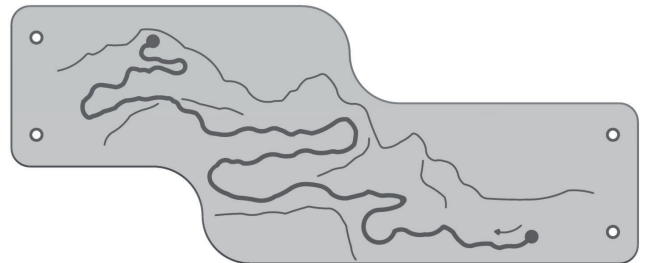

**Mna031 x1**

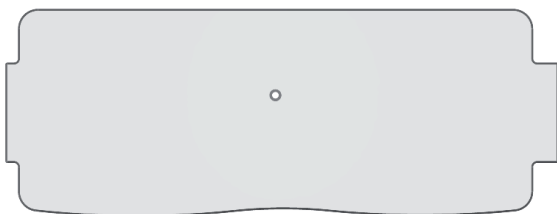

**Mna010 x1**



**Mna011 x1**



**Mna012 x1**

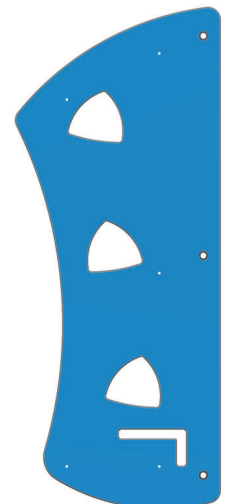

**Mna013 x1**

# Mnw003

Standard Views

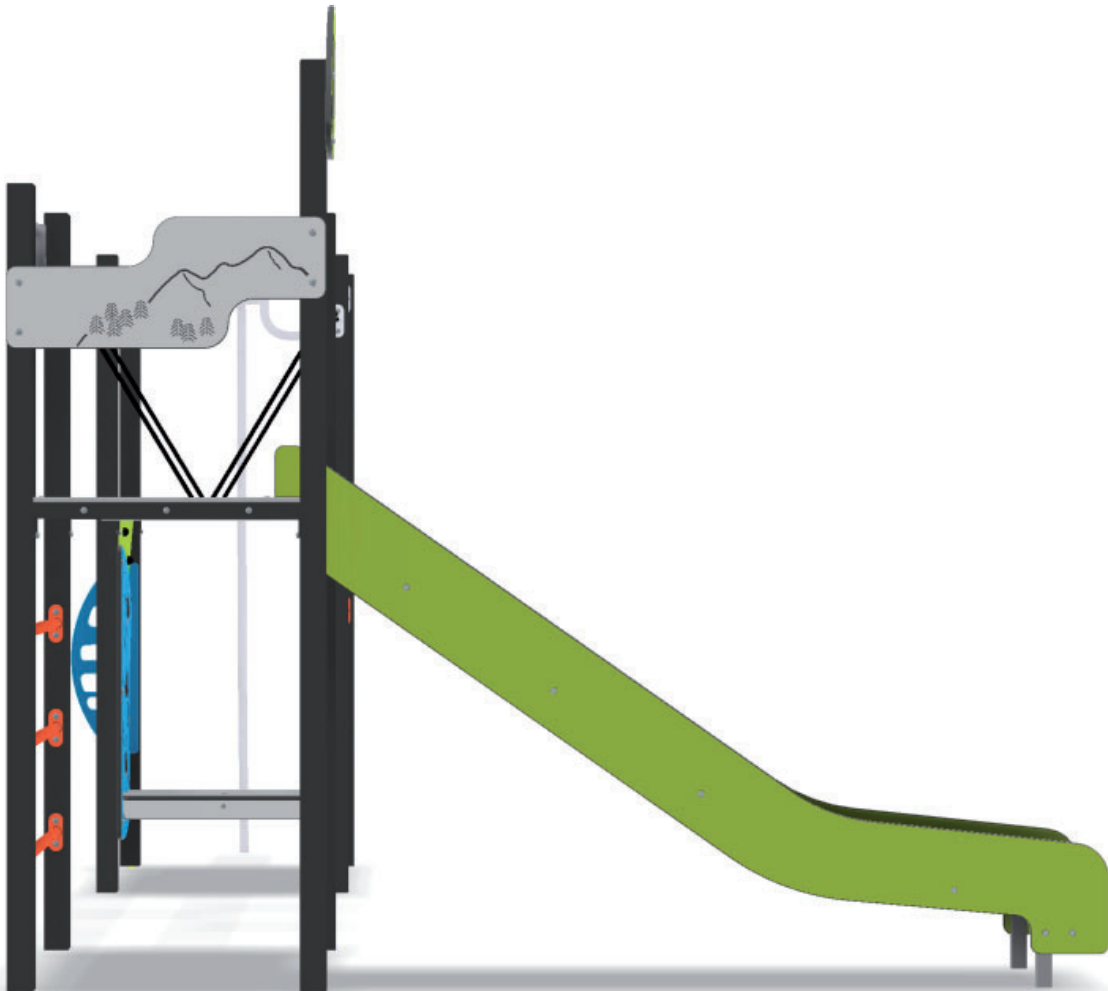
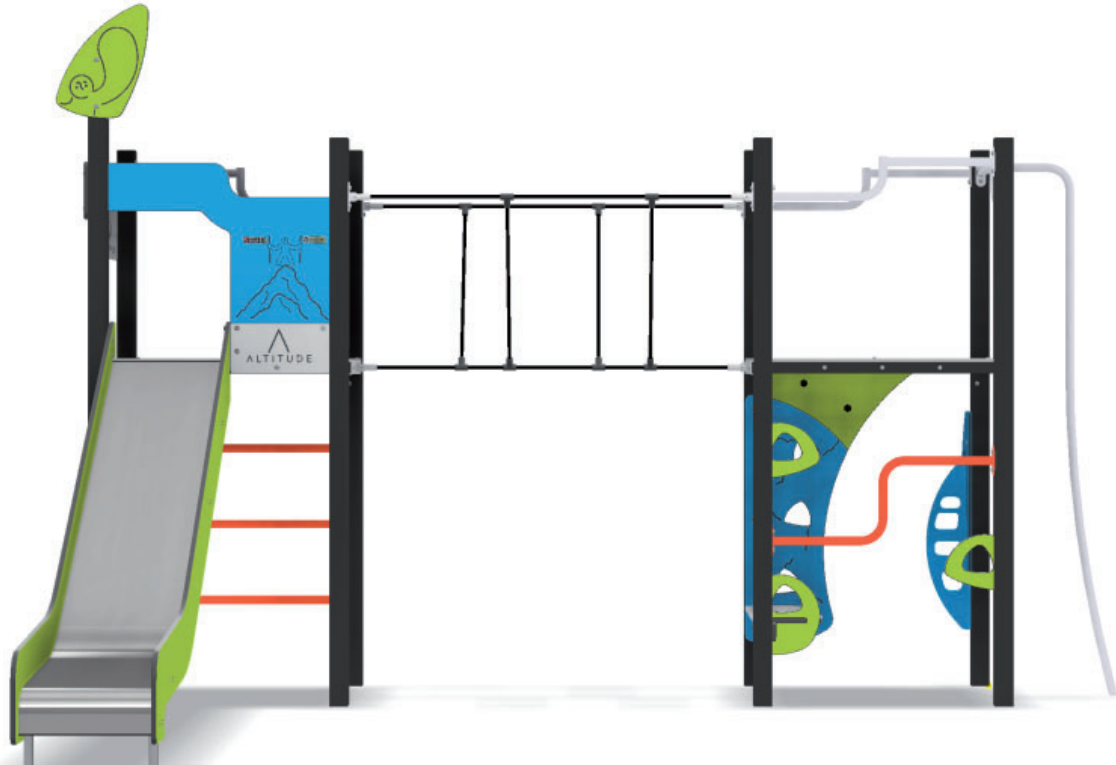

# Mnw003

Standard Views

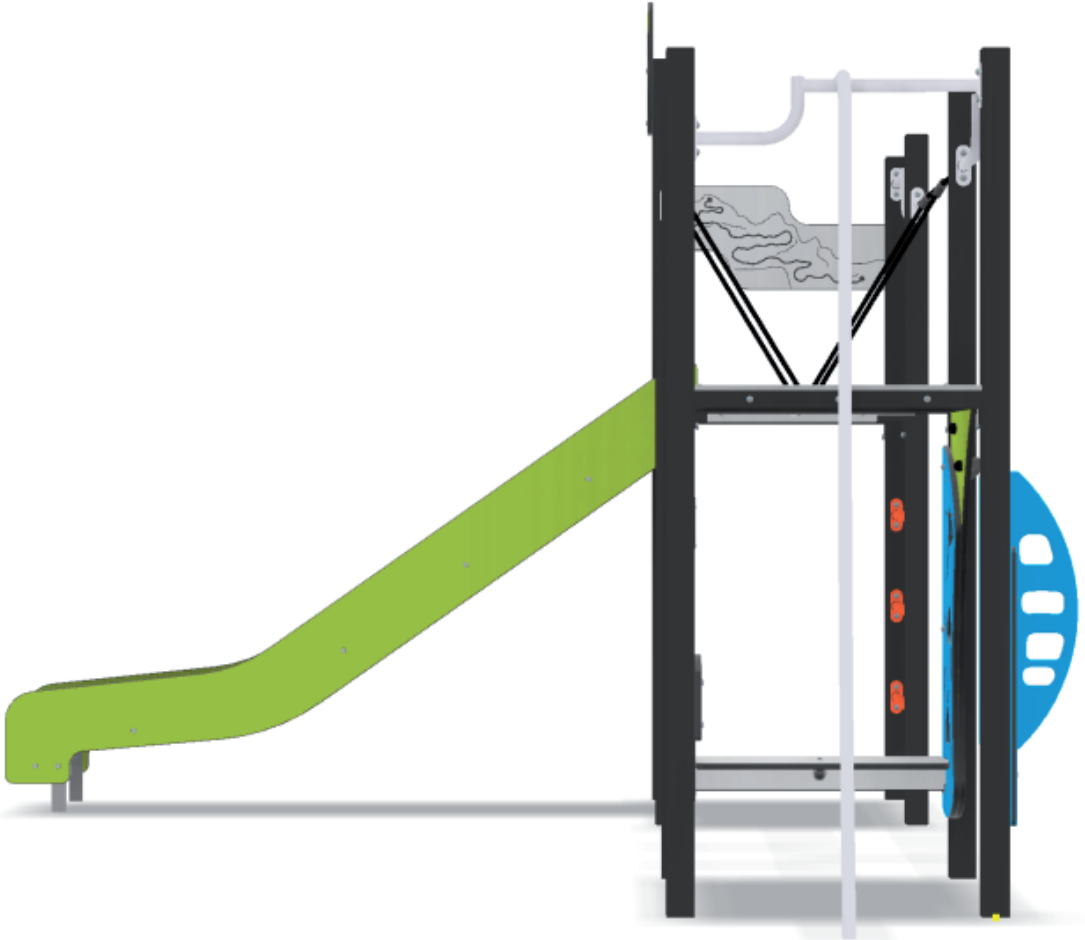

# Mnw003

## Standard Fixings

### 19mm THK Panel to Framework.

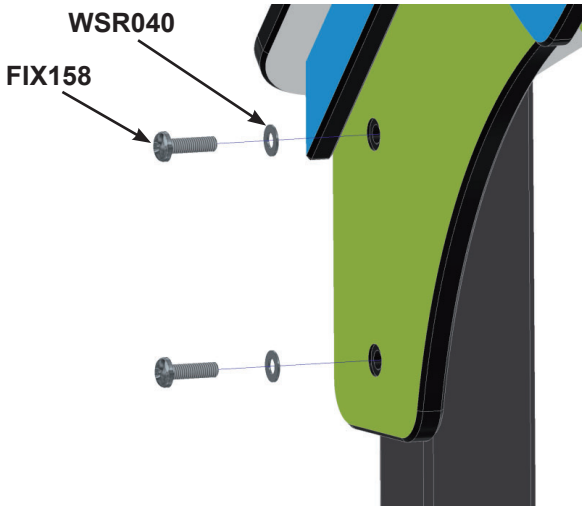

Ref	Description	Qty
WSR040	M10 Plain Washer	1
FIX158	M10 x 35 Security Bolt	1

### 5mm Plates to Framework.

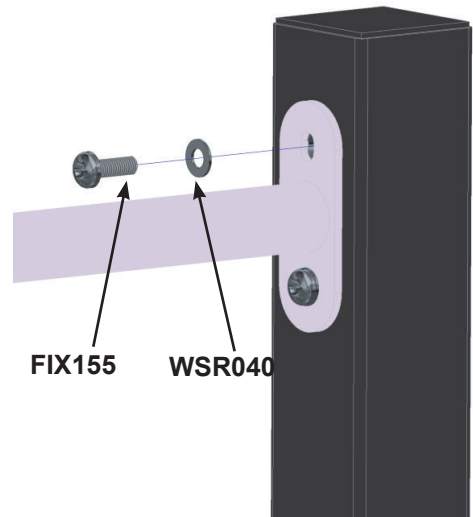

Ref	Description	Qty
WSR040	M10 Plain Washer	1
FIX155	M10 x 30 Security Bolt	1

### 19mm Panel to 19mm Panel.

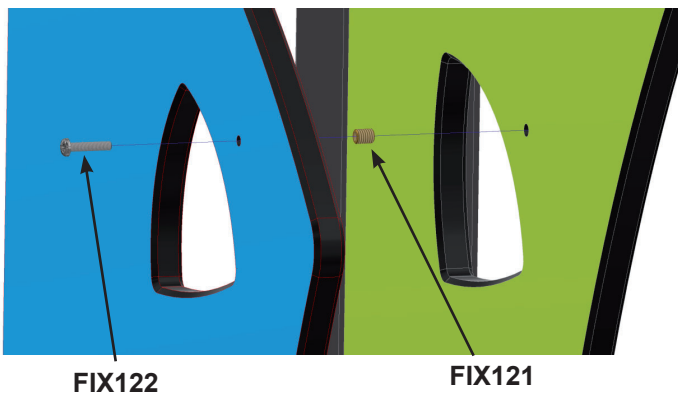

Ref	Description	Qty
FIX122	M5 x 25 Security bolt	1
FIX121	M5 Brass Insert	1

### Capping Holes.

**FIX150**  
Cap all holes after unit is fully assembled.

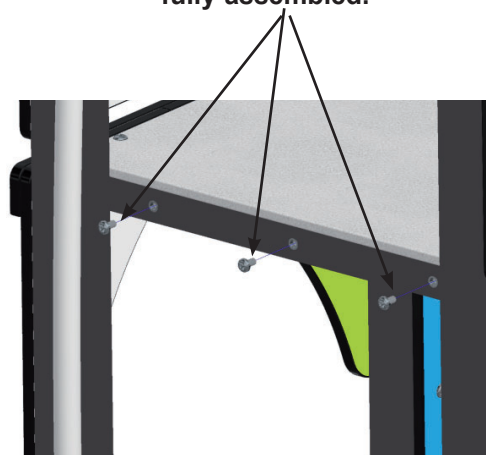

Ref	Description
FIX150	M10 x 20 Security Bolt

# Mnw003

## Deck Fixings

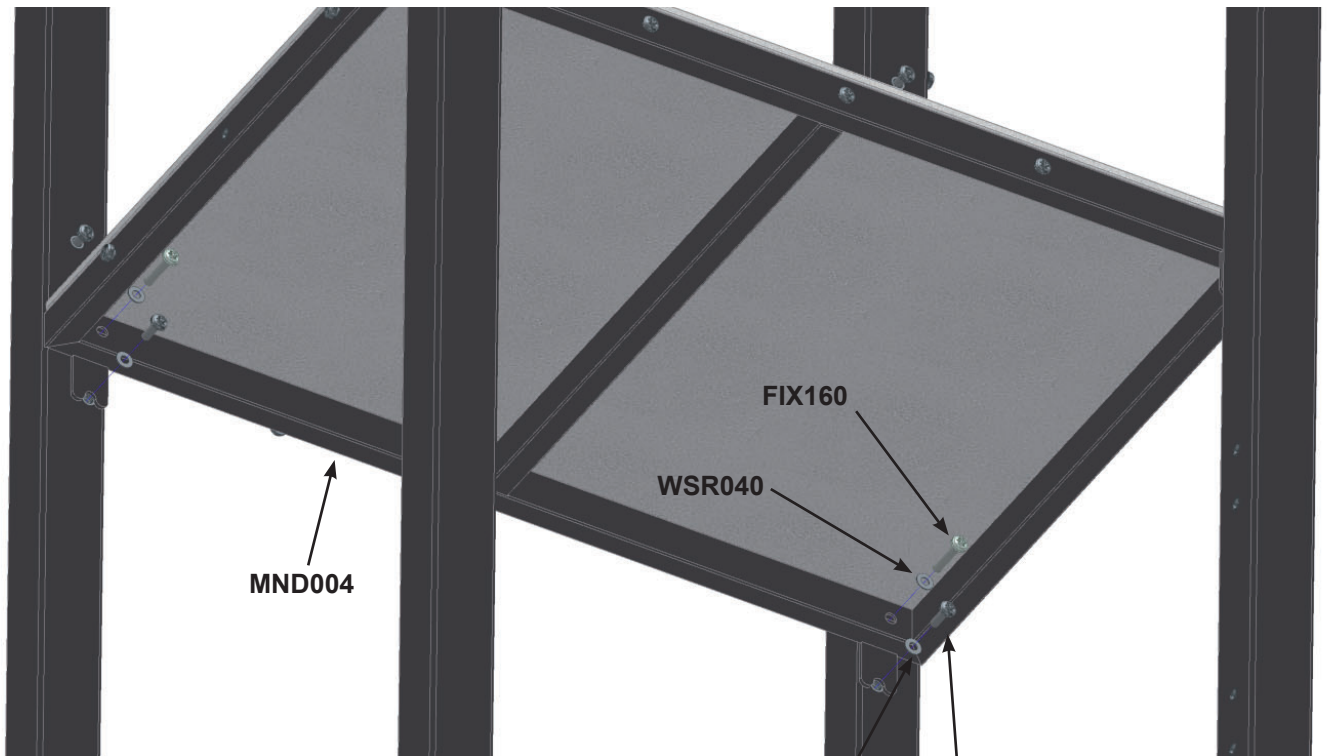

Ref	Description	Qty
MND004	Deck Assembly	1
WSR040	M10 Plain Washer	8
FIX155	M10 x 30 Security Bolt	4
FIX160	M10 x 50 Security Bolt	4

WSR040

FIX155

# Mnw003

## Slide Assembly

1. **Fit PED302 to slide sides as shown, prior to fixing slide to the entrance panel / post.**

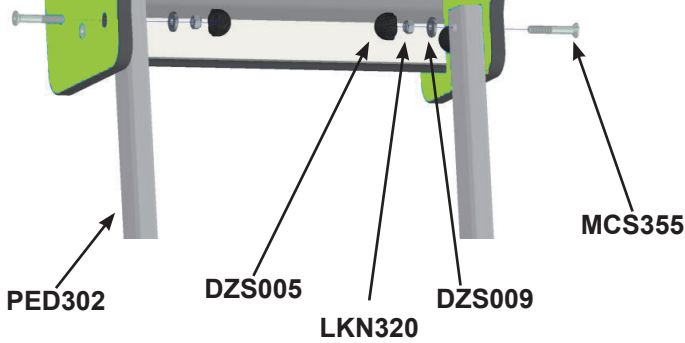

Ref	Description	Qty
DZS005	M10 Nut Cover	2
LKN320	M10 Nyloc Nut	2
DZS009	M10 Step Washer	2
MCS355	M10 x 65 CSK Bolt	2
MSL002	200mm Spragging Iron	2

2. **Ensure inside of L-Bracket consists of x1 Nut Cover and x1 Bolt as shown below. To avoid toggle trap.**

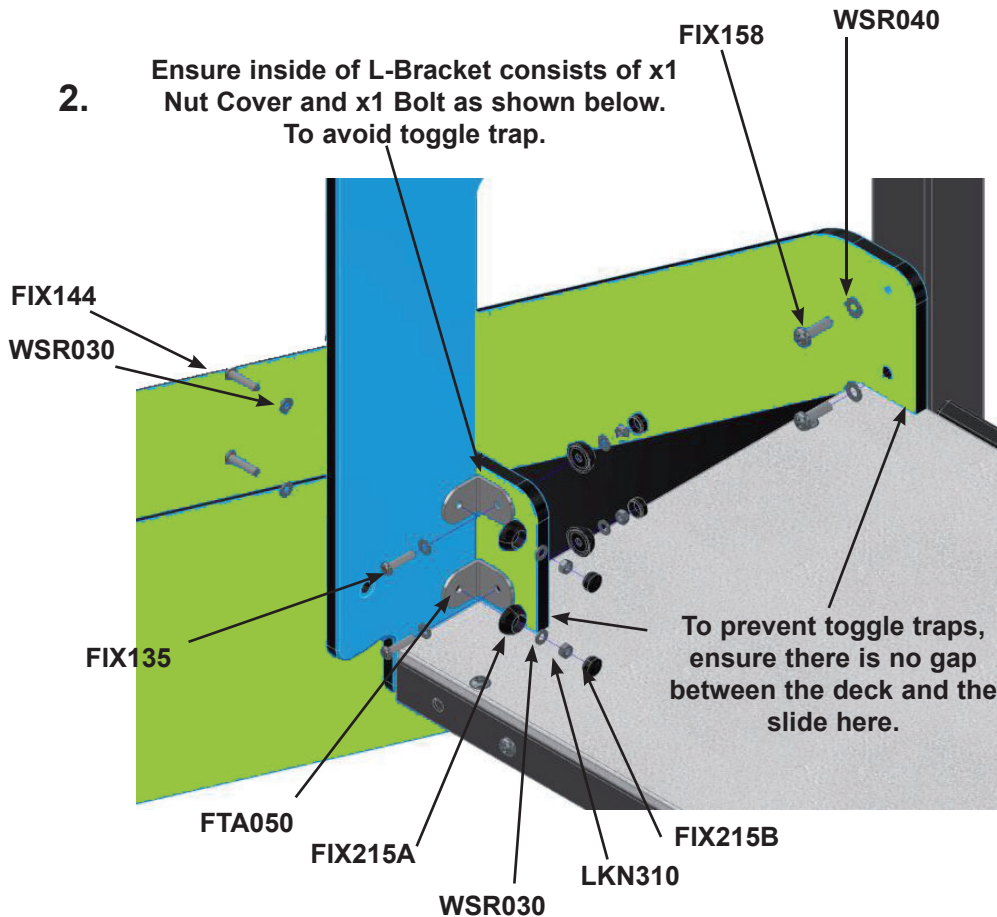

To prevent toggle traps, ensure there is no gap between the deck and the slide here.

Ref	Description
WSR030	M8 Plain Washer
FIX135	M8 x 35 Security Bolt
FIX215A	M8 2 Part Cover - Base
LKN310	M8 Nyloc Nut
FIX215B	M8 2 Part Cover - Cap
FTA050	L-Bracket 50 x 50 St/St
FIX158	M10 x 35 Security Bolt
WSR040	M10 Plain Washer
FIX144	M8 x 55 Security Bolt



# Mnw003

## Assembly Fixings

### Seat Assembly.

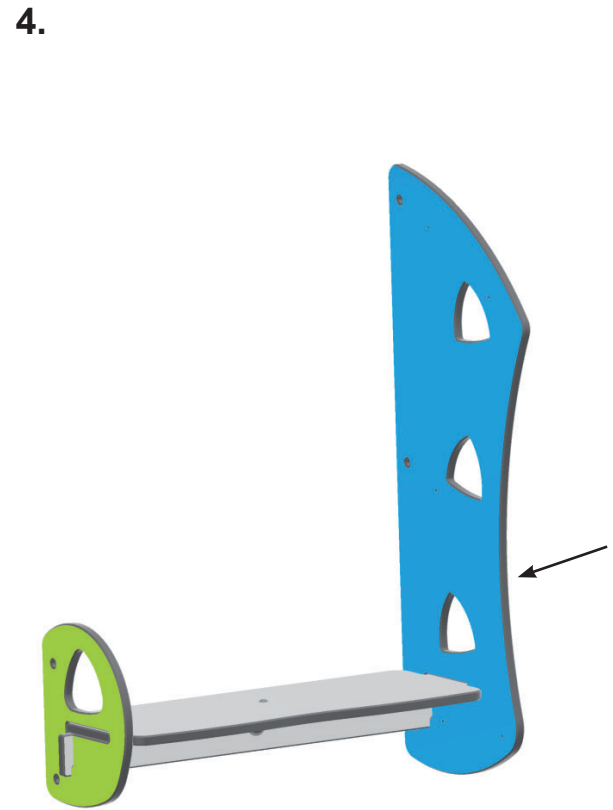
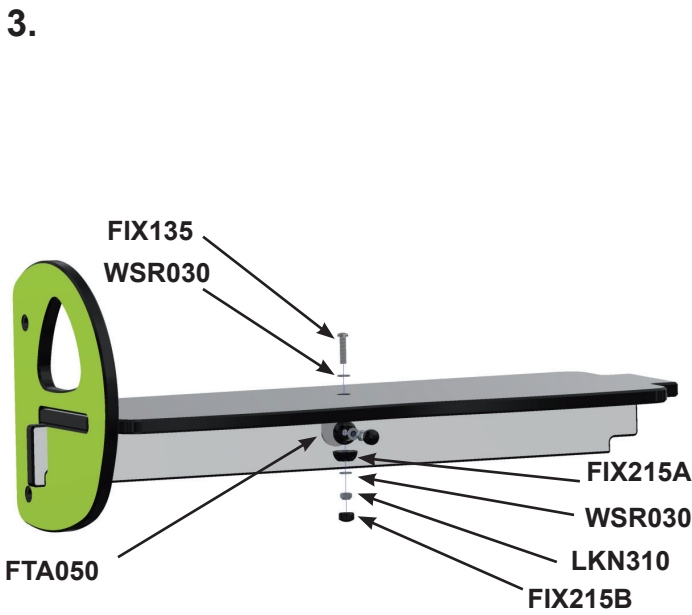
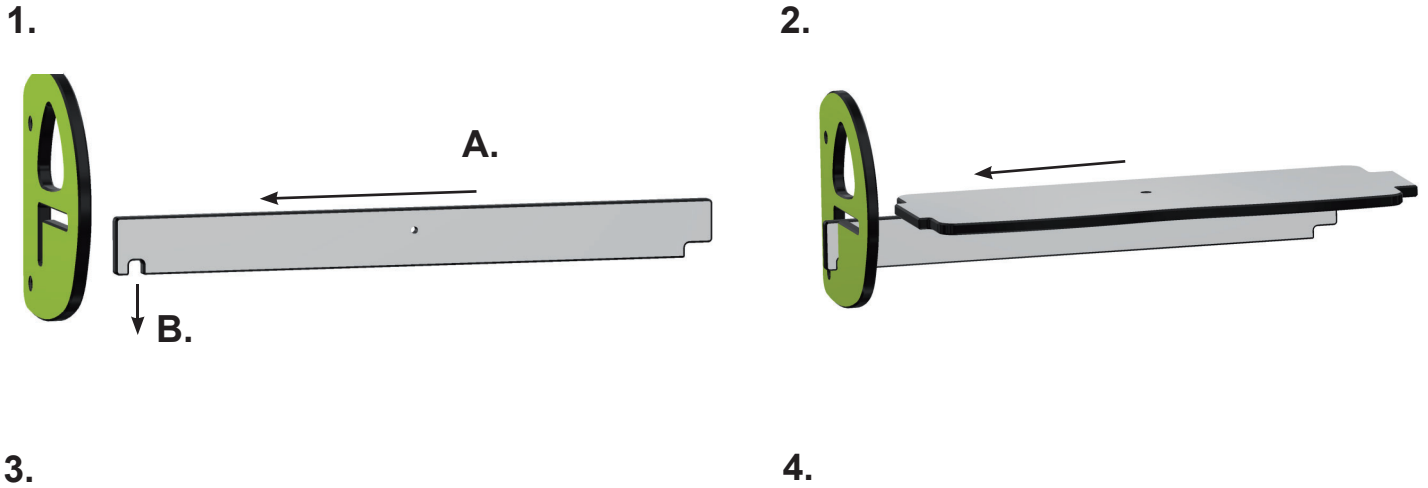

Ref	Description	Qty
WSR030	M8 Plain Washer	4
FIX135	M8 x 35 Security Bolt	2
FIX215A	M8 2 Part Cover - Base	2
LKN310	M8 Nyloc Nut	2
FIX215B	M8 2 Part Cover - Cap	2
FTA050	L-Bracket 50 x 50 St/St	1

# Mnw003

## Assembly Fixings

### Seat Assembly.

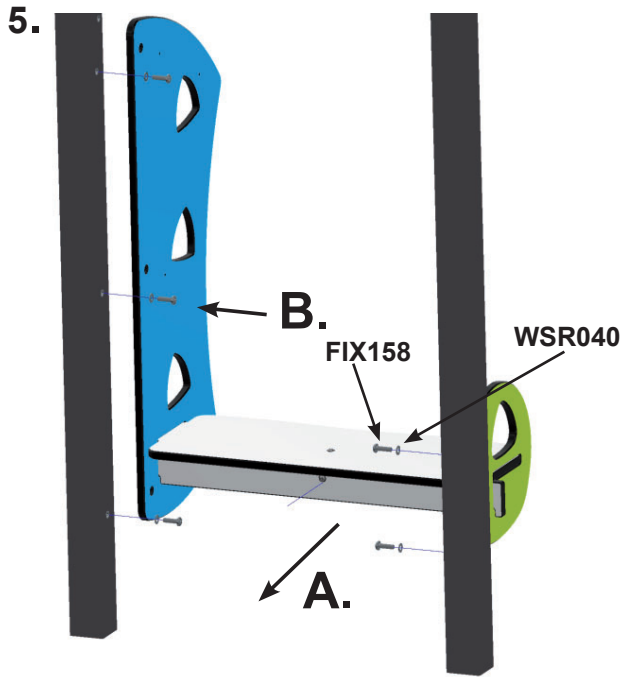

Ref	Description	Qty
WSR040	M10 Plain Washer	5
FIX158	M10 X 35 Security Bolt	5

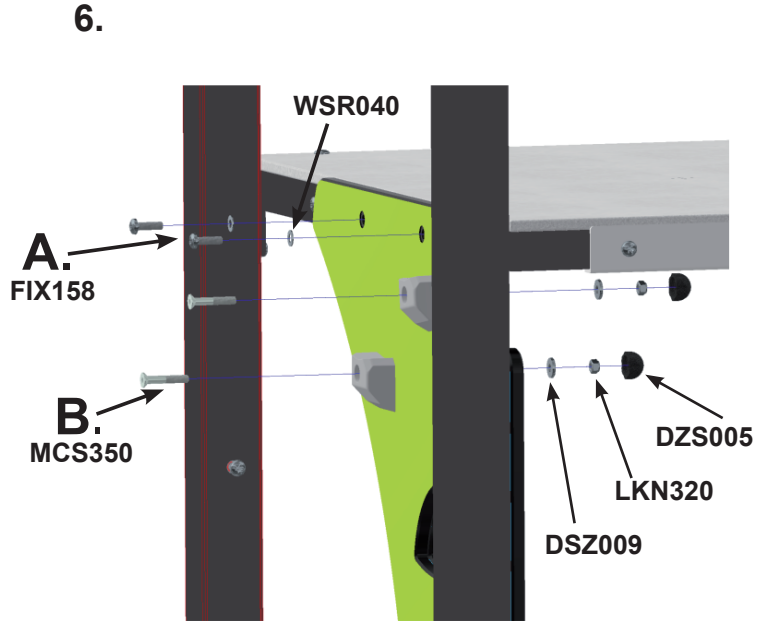

Ref	Description	Qty
WSR040	M10 Plain Washer	2
FIX158	M10 X 35 Security Bolt	2
MCS350	M10 x 60 Hex C/sink Screw	2
DSZ009	M10 Cover Washer	2
LKN320	M10 Nyloc Nut	2
DSZ005	M10 Nut Cover	2

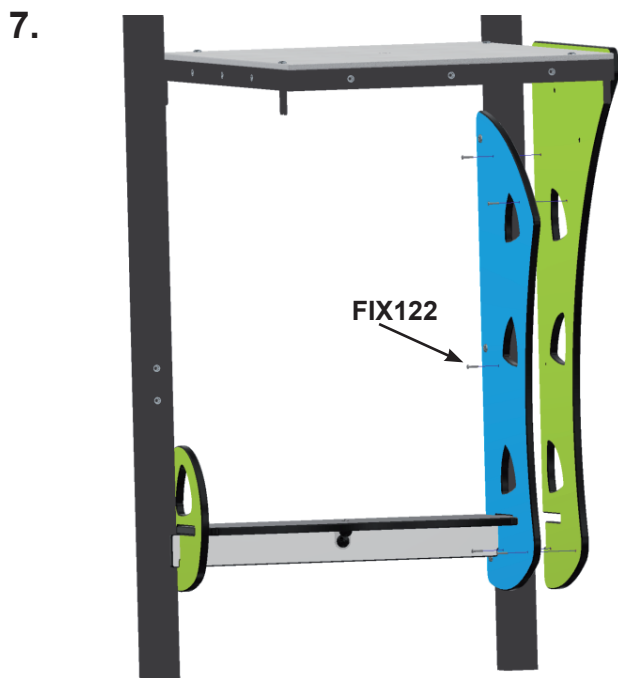

Ref	Description	Qty
FIX122	M5 x 25 Security Bolt	5

# Mnw003

## Assembly Fixings

### V-Bridge Assembly.

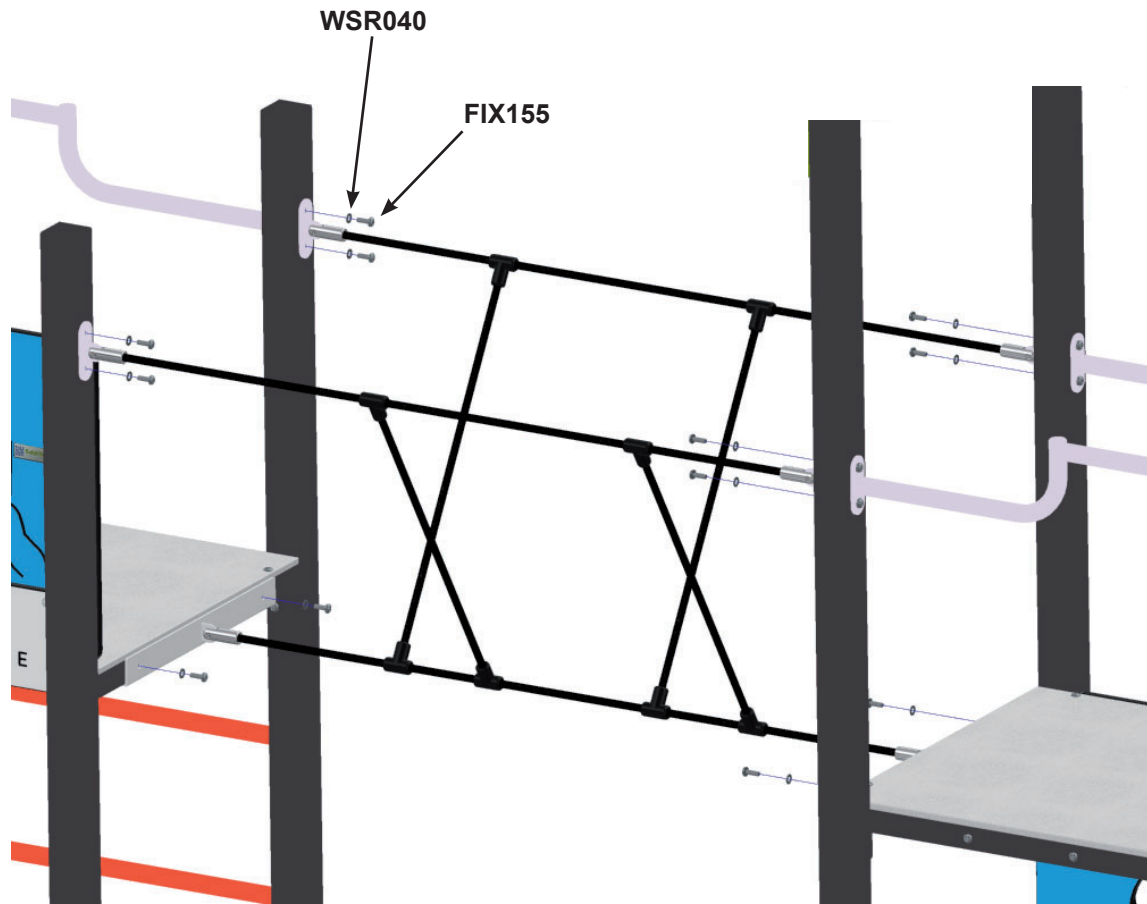

Ref	Description	Qty
WSR040	M10 Plain Washer	12
FIX155	M10 x 30 Security Bolt	12

# Mnw003

## Unit Maintenance Instructions

### NOTE

The warranty is invalidated if these instructions are not followed.  
All wood needs annual inspection and retreatment where required.

### Recommended Regular Inspection and Maintenance

	Interval Days				
	7	14	28	56	365
Check stability of structure, tighten connections if required.	<input type="checkbox"/>	<input type="checkbox"/>	<input type="checkbox"/>	<input checked="" type="checkbox"/>	<input type="checkbox"/>
Check all uprights at ground level for corrosion and/or rot. Replace any defective parts.	<input type="checkbox"/>	<input type="checkbox"/>	<input type="checkbox"/>	<input type="checkbox"/>	<input checked="" type="checkbox"/>
Check all painted elements for damage, rub down and repaint or replace as required.	<input type="checkbox"/>	<input type="checkbox"/>	<input type="checkbox"/>	<input checked="" type="checkbox"/>	<input type="checkbox"/>
Check chain/ropework assemblies for wear and damage, replace if required.	<input type="checkbox"/>	<input checked="" type="checkbox"/>	<input type="checkbox"/>	<input type="checkbox"/>	<input type="checkbox"/>
Check rotating and pivot points for wear and smooth running lubricate or replace if required.	<input type="checkbox"/>	<input type="checkbox"/>	<input checked="" type="checkbox"/>	<input type="checkbox"/>	<input type="checkbox"/>
Check rubber parts for wear and/or damage, replace if required.	<input type="checkbox"/>	<input type="checkbox"/>	<input checked="" type="checkbox"/>	<input type="checkbox"/>	<input type="checkbox"/>
Check tension cables, adjust if required.	<input type="checkbox"/>	<input type="checkbox"/>	<input checked="" type="checkbox"/>	<input type="checkbox"/>	<input type="checkbox"/>
Check wear of cables, replace if required.	<input type="checkbox"/>	<input type="checkbox"/>	<input checked="" type="checkbox"/>	<input type="checkbox"/>	<input type="checkbox"/>
Check slide chutes for smoothness and any foreign elements, remove any found.	<input type="checkbox"/>	<input type="checkbox"/>	<input checked="" type="checkbox"/>	<input type="checkbox"/>	<input type="checkbox"/>
Check rubber safety surfaces for damage and poor performance, repair or replace if required.	<input type="checkbox"/>	<input type="checkbox"/>	<input type="checkbox"/>	<input checked="" type="checkbox"/>	<input type="checkbox"/>
Check loose fill safety surfaces, remove any foreign elements, rake level and top up if required.	<input type="checkbox"/>	<input type="checkbox"/>	<input checked="" type="checkbox"/>	<input type="checkbox"/>	<input type="checkbox"/>

### Disposal Instructions

All components should be broken down into categories of:-

- 1 **Mild Steel** - all activities and frames
- 2 **Stainless Steel** - all Slides, Mirror Panels.
- 3 **Aluminium** - all Playzone and Toddlerzone Posts.
- 4 **Galvanised Steel** - all Chains and Teenzone Posts.
- 5 **Moulded Rubber Products without steel inserts** - all Toddlerzone Caps and edge details.
- 6 **Timber** - all natural timber, plywood, and MDF panels.

Wherever possible these materials should be taken to specialist recycling organisations and recycled.

In some cases where composite materials are used, then disposal at land fill sites is the only alternative such as:

- 7 **Moulded Rubber Products encasing steel inserts** - all Swing Seats, Deck Tops, Duo/Dizzy Disc Tops.
- 8 **High Pressure Laminate** - all Toddlerzone, Playzone and Teenzone Panels.
- 9 **Steel Core Polypropylene Rope** - all Scramble Nets, Space Nets, Playzone/Toddlerzone Ropes.
- 10 **High Density Polyethylene** - Fantasy Range Panels.